

Koal Touch Series

Indicator Controller

USER'S MANUAL

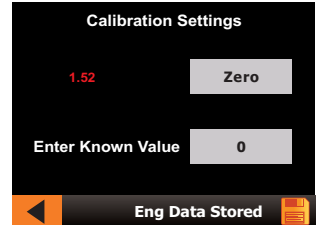
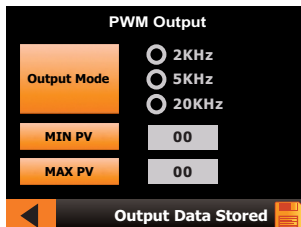
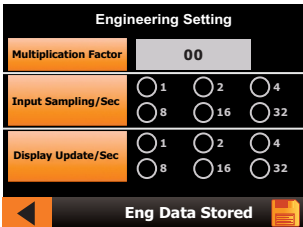
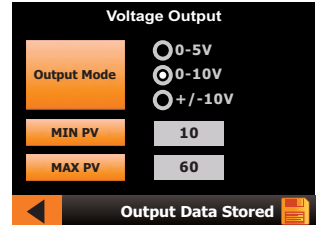
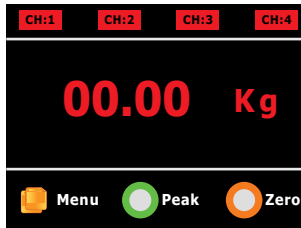
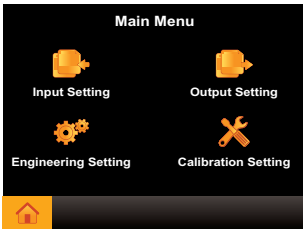

Read the user's manual carefully before starting to use the unit or software.
 Producer reserves the right to implement changes without prior notice.

Seetharam Mechatronics Pvt. Ltd

Office: #3, 8th Street, Vaishnavi Nagar, Chennai-600 109, India.

Web: www.seetharam.in

Email: ram@seetharam.in

Index

Section	Title	Pages
1	Safety/Proper Usage	03
2	Warning	04
3	Product Description	05
4	Outline Drawing & Panel Cutout	06
5	Mounting	07
6	Pin Configuration	08
7	Communication	10
8	Screen Setting	11
9	Icon Description	12
10	Main Menu	13
11	Koal Touch Strain	14
11.1	KTS - Input Setting	14
11.2	KTA - Input Setting	16
11.3	KTG - Input Setting	17
11.4	KTE - Input Setting	18
12	Output Setting	19
12.1	Alarm Output Setting	19
12.2	Signal Setting	23
12.3	Communication (KTS & KTA)	26
13	Engineering Setting	27
14	Calibration Settings	28

1. Safety / Proper Usage

- Don't use sharp edge tools/equipment on touch screen
- In order to minimize fire or electric shock hazard, the unit must be protected against atmospheric precipitation and excessive humidity.
- Do not use the unit in areas threatened with excessive shocks, vibrations, dust, humidity, corrosive gasses and oils.
- Do not use the unit in areas where there is risk of explosions.
- Do not use the unit in areas with significant temperature variations, exposure to condensation or ice.
- Do not use the unit in areas exposed to direct sunlight.
- Make sure that the ambient temperature (e.g. inside the control box) does not exceed the recommended values. In such cases forced cooling of the unit must be considered (e.g. by using a ventilator).
- Do not attempt to disassemble, repair or modify the unit yourself. The unit has no user serviceable parts. Defective units must be disconnected and submitted for repairs at an authorized service centre
- In an environment with a high amount of moisture or humidity, create a drip loop on the cable to prevent any water from flowing into the sensor.

2. Warning

The indicator must not be modified from the design or safety engineering point of view except with our express agreement. Any modification shall exclude all liability on our part for any damage resulting there from.

Koal Touch Series

Strain, Analog, Gaman & Encoder

3. Product Description

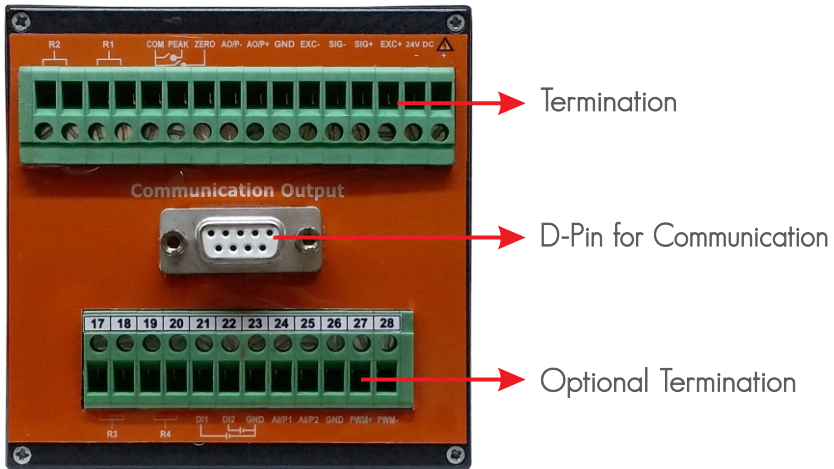
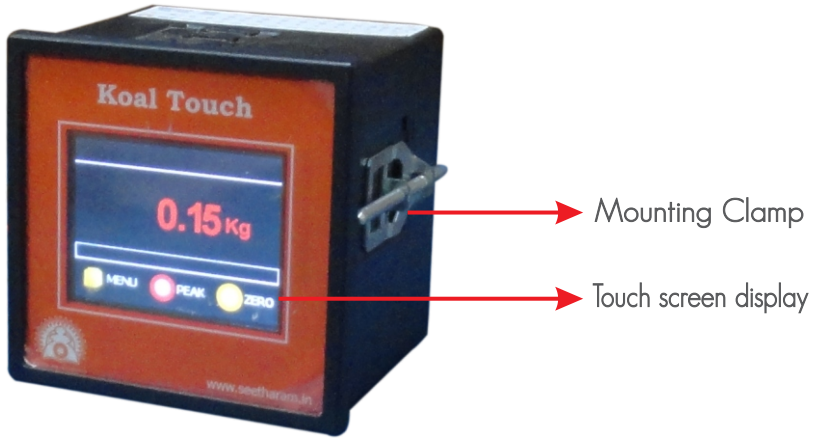

4. Outline Drawing & Panel Cutout

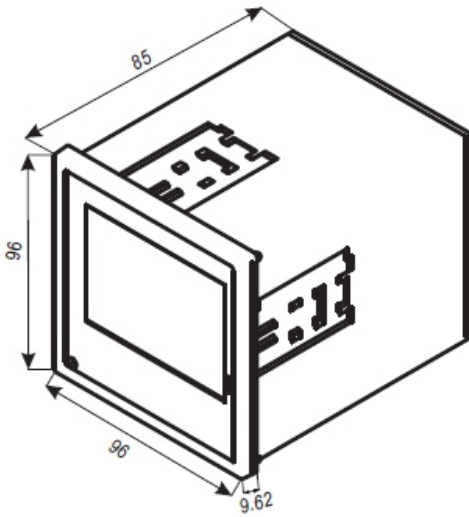

Panel Cutout

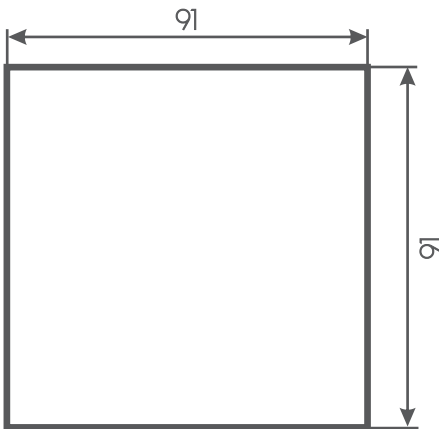

All Dimensions are in mm

5. Mounting

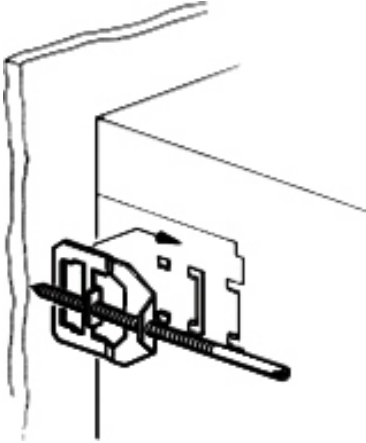

The Screw clamp is placed on the enclosure from the rear of the control panel.

After this, the enclosure is pressed firmly on to the rear wall of the control panel through the integrated screw.

6. Pin Configuration

Koal Touch Strain (KTS) – Strain output sensor

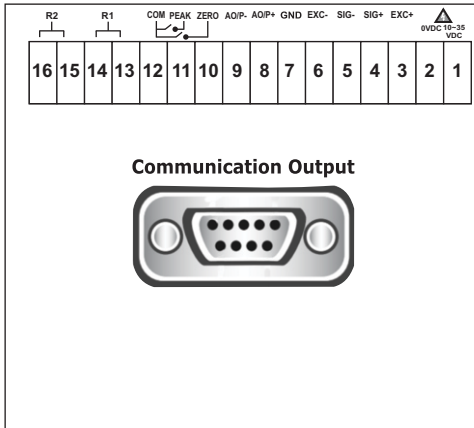

- 1 - 10-35V DC
- 2 - 0V DC
- 3 - Exc +
- 4 - Sig +
- 5 - Sig -
- 6 - Exc -
- 7 - GND
- 8 - A O/P+
- 9 - A O/P -
- 10 - Zero
- 11 - Peak
- 12 - COM
- 13 - NO1
- 14 - COM1
- 15 - NO2
- 16 - COM2

Koal Touch Analog (KTA) – Analog output sensor

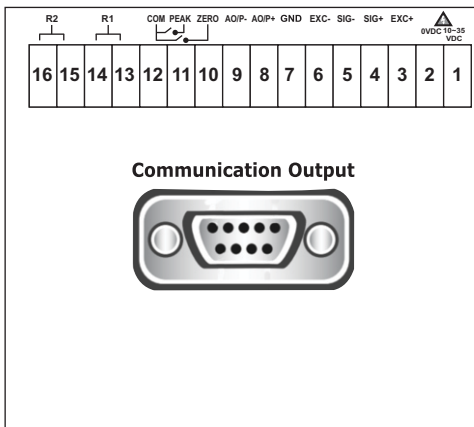

- 1 - 10-35V DC
- 2 - 0V DC
- 3 - Exc +
- 4 - Sig +
- 5 - Sig -
- 6 - Exc -
- 7 - GND
- 8 - A O/P+
- 9 - A O/P -
- 10 - Zero
- 11 - Peak
- 12 - COM
- 13 - NO1
- 14 - COM1
- 15 - NO2
- 16 - COM2

6. Pin Configuration

Koal Touch Gaman (KTG) – Encoder Modbus Output

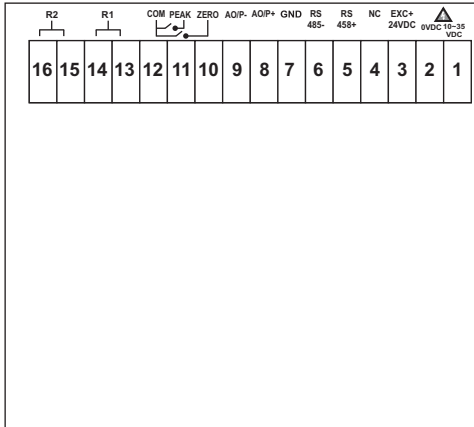

- 1 - 10-35V DC
- 2 - 0V DC
- 3 - Exc+ 24V DC
- 4 - NC
- 5 - RS 485+
- 6 - RS 485-
- 7 - GND
- 8 - A O/P+
- 9 - A O/P -
- 10 - Zero
- 11 - Peak
- 12 - COM
- 13 - NO1
- 14 - COM1
- 15 - NO2
- 16 - COM2

Koal Touch Encoder (KTE) – TTL Output Encoder

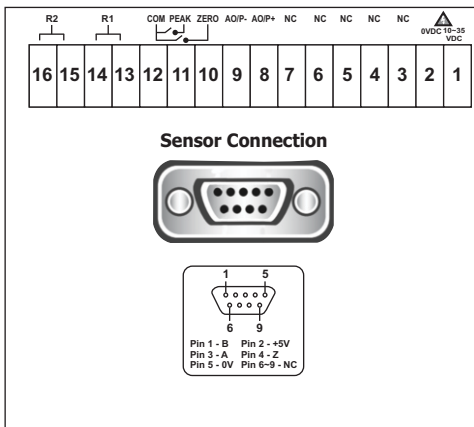

- 1 - 10-35V DC
- 2 - 0V DC
- 3 - NC
- 4 - NC
- 5 - NC
- 6 - NC
- 7 - NC
- 8 - A O/P+
- 9 - A O/P -
- 10 - Zero
- 11 - Peak
- 12 - COM
- 13 - NO1
- 14 - COM1
- 15 - NO2
- 16 - COM2

7. Communication

Pin Configuration	
Pin 1	NA
Pin 2	RS232 TX
Pin 3	RS 232 RX
Pin 4	NA
Pin 5	RS232 GND
Pin 6	NA
Pin 7	RS485 A
Pin 8	RS485 B
Pin 9	NA

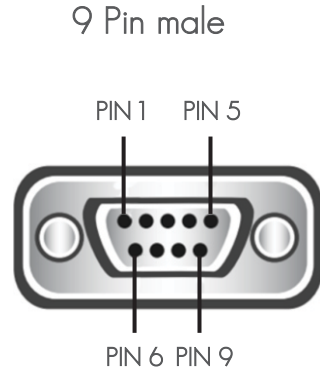

Screen Details & Controls

The Koal touch series is powered by 10 ~ 35V DC

8. Screen Setting



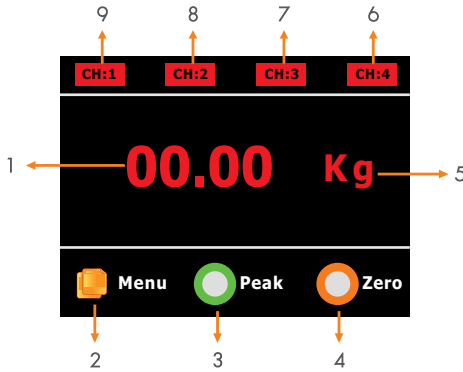

Home Screen



S.No	Parameters	Description
1	Display Reading	The current display of sensor reading. See Section for details.
2	Menu	Navigate to Input Output Engineering Setting Calibration
3	Peak	Displays only max. value when enabled Peak Enabled - Button Red Color Peak Disabled - Button Green Color
4	Zero	When enabled the current value is zeroed
5	Units	Selected Unit Display
6,7,	Alarm Channel	Displays the status of alarm channel
8,9		Red - Disabled Green - Enabled

Note: kindly touch icon for navigation to following screen.

9. Icon Description

Icons	Description
	Home Button - Navigate to Home Screen
	Forward - Navigate to Next Screen
	Backward - Navigate to Previous Screen
	Backward - Navigate to Previous Screen
	Save Button - To Save the Settings

Numeric Screen

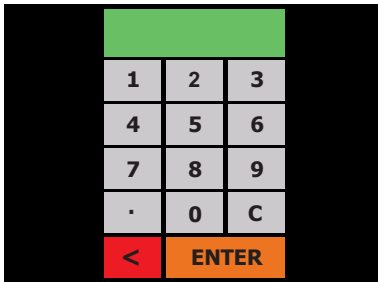

This screen will pop up for numerical data entry.

10. Main Menu

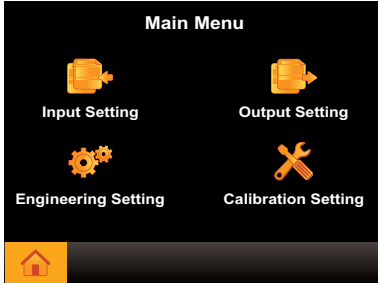

Main menu consists

1. Input setting
2. Output setting
3. Engineering setting
4. Calibration setting

} Common for all
Koal Touch Series

11. Input Setting - KTS

11.1 Koal Touch Strain (KTS) Input Setting

Sensor Type Selection

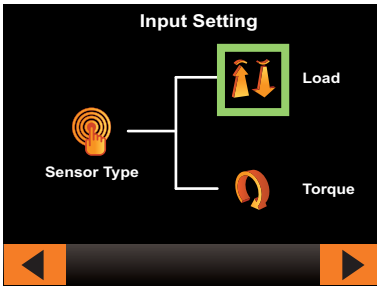

Load Setting

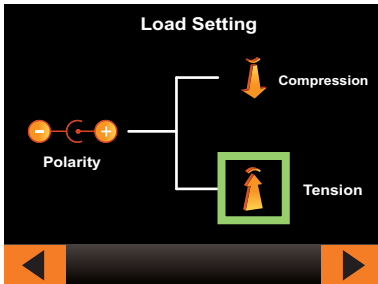

Compression - unipolar

Tension - Bi-polar

11. Input Setting - KTS

Excitation Voltage

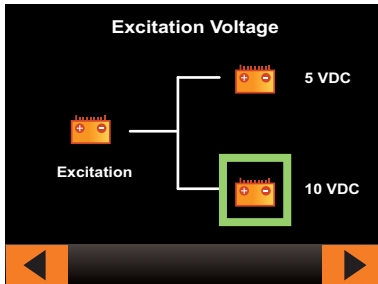

Select the recommended excitation as specified in sensor datasheet.

Sensor Input

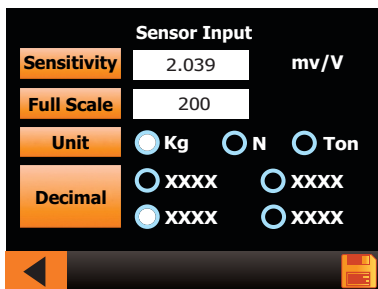

- Enter sensitivity of sensor as mentioned in datasheet.
- Enter full scale of sensor to be measured.
- Select the unit to be displayed of sensor (unit conversion not available)
- Select the appropriate decimal point.
- Save the setting.

11. Input Setting - KTA

11.2 Koal Touch Analog (KTA) Input Setting

Excitation Voltage

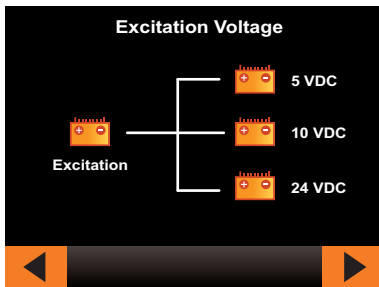

Select the recommended excitation as specified in sensor datasheet

Input Voltage

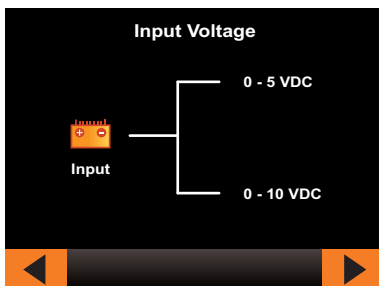

Select the output of sensor connected. (Output of sensor is input to indicator)

11. Input Setting - KTG

11.3 Koal Touch Gaman (KTG) Input Setting

Input Setting

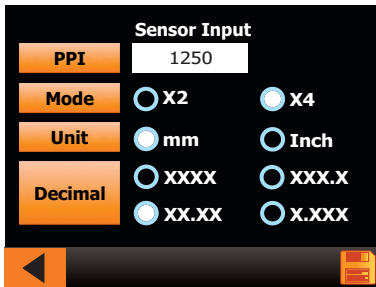

- Enter Pulse Per Inch (PPI) of sensor connected
- Select Mode X2 (dual phasing) (or) X4 (quad phasing)
- Select the unit to be displayed of sensor (unit conversion not available)
- Select the appropriate decimal point
- Save the setting

11. Input Setting - KTE

11.4 Koal Touch Encoder (KTE) Input Setting

Input Setting

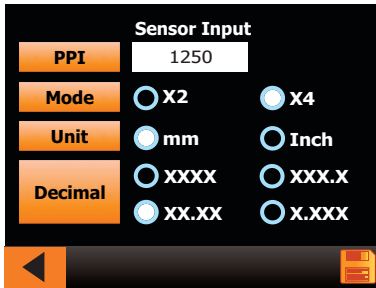

- Enter Pulse Per Inch (PPI) of sensor connected
- Select Mode X2 (dual phasing) (or) X4 (quad phasing)
- Select the unit to be displayed of sensor (unit conversion not available)
- Select the appropriate decimal point
- Save the setting

12. Output Setting

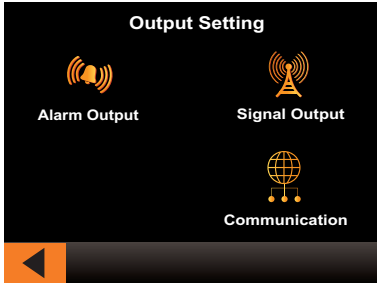

12.1 Alarm Output Setting

Alarm output consists of four channels in which conditions can be set and trigger the relay output accordingly.

12.1.1 Channel Navigation Screen

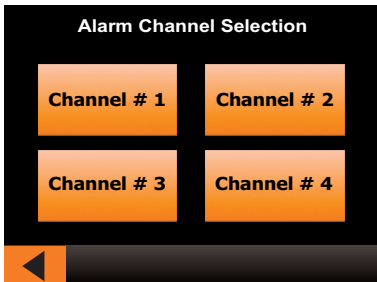

12. Output Setting

12.1.2 Channel Setting Screen

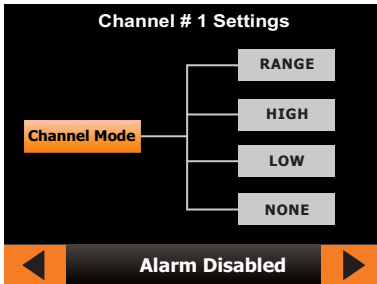

12.1.3 Range Setting

Energize (or) De-energize relay between two set conditions

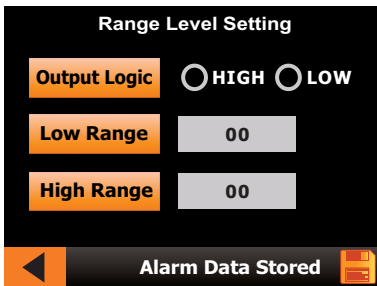

Output logic - select **HIGH** for energizing the relay between the set values. Till then the relay will be de -energized.

Select **LOW** for de - energizing the relay between the set values. Till then the relay will be energized.

Low range - Enter the low range value

High range - Enter the high range value

After entering data select save button upon which "**Alarm data stored**". Once saved, it will be navigated to alarm channel selection screen.

12. Output Setting

12.1.4 High Setting

Energize (or) De-energize relay output greater than the given value.

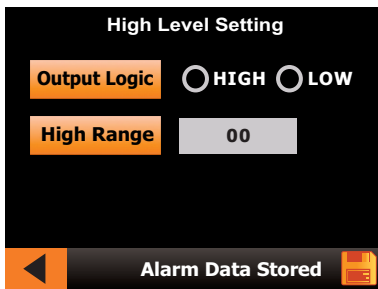

Output logic - select **HIGH** for energizing the relay after the values. Till then the relay will be de - energized.

Select **LOW** for de - energizing the relay after the values. Till then the relay will be energized.

High range - Enter the high range value

After entering data select save button upon which "**Alarm data stored**". Once saved, it will be navigated to alarm channel selection screen.

12. Output Setting

12.1.5 Low Setting

Energize (or) De-energize relay output lesser than the given value.

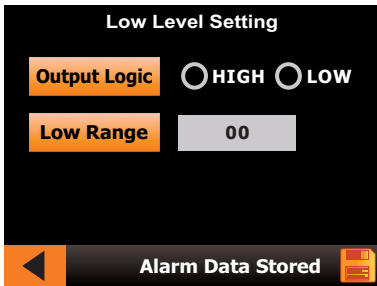

Output logic - select **HIGH** for energizing the relay below the values. Till then the relay will be de - energized.

Select **LOW** for de - energizing the relay below the values. Till then the relay will be energized.

Low range - Enter the low range value

After entering data select save button upon which "**Alarm data stored**". Once saved, it will be navigated to alarm channel selection screen.

12. Output Setting

12.2 Signal Output

Select type of analog output required for your process/application.

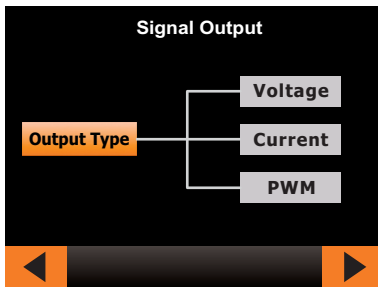

12.2.1 Voltage Setting

The voltage will be scaled between minimum process value and maximum process value

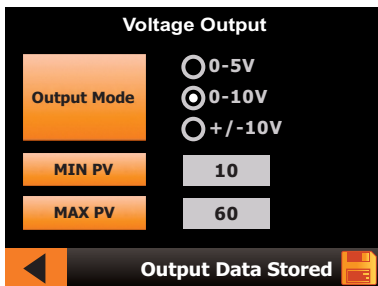

Output mode - Select the required output voltage for your process.

Min PV- Enter minimum process value

Max PV - Enter maximum process value

After entering data select save button upon which "Output data stored". Once saved, it will be navigated to output setting screen.

12. Output Setting

12.2.2 Current Setting

The current will be scaled between minimum process value and maximum process value

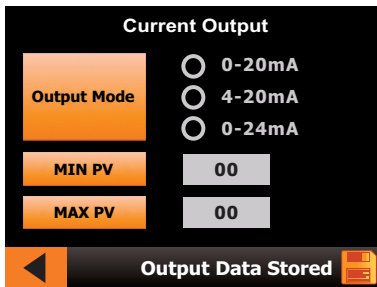

Output mode - Select the required current output for your process.

Min PV- Enter minimum process value

Max PV - Enter maximum process value

After entering data select save button upon which "**Output data stored**". Once saved, it will be navigated to output setting screen.

After entering data select save button upon which "**Output data stored**". Once saved, it will be navigated to output setting screen.

12. Output Setting

12.2.3 PWM Setting

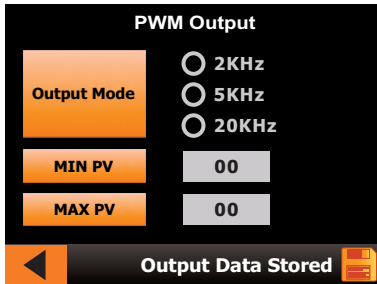

Output mode - Select the required pwm output for your process.

Min PV - Enter minimum process value

Max PV - Enter maximum process value

After entering data select save button upon which "Output data stored". Once saved, it will be navigated to output setting screen.

12. Output Setting

12.3 Communication (for KTS & KTA)

Communication Setting

DEVICE ID

MODE RS232 RS485

BAUD 9600 19200
 56000 115200

Output Data Stored

Enter device ID

Select type of communication

Select baud rate based on the device connected to koal touch.

After entering data select save button upon which "Com data stored".

RS232 - Send String as **\$DATA!<CR><LF>**

RS485 - Get Data from **Register Address 40001**

13. Engineering Settings

Engineering Setting	
Multiplication Factor	00
Input Sampling/Sec	<input type="radio"/> 1 <input type="radio"/> 2 <input type="radio"/> 4 <input type="radio"/> 8 <input type="radio"/> 16 <input type="radio"/> 32
Display Update/Sec	<input type="radio"/> 1 <input type="radio"/> 2 <input type="radio"/> 4 <input type="radio"/> 8 <input type="radio"/> 16 <input type="radio"/> 32
◀ Eng Data Stored ▶	

Enter multiplication factor to be multiplied with calibrated value

Input sampling/sec - Select options for required samples to be read by the indicator.

Display update/sec - Select options for how many times the display has to be updated.

After entering data select save button upon which “Eng data stored”.

14. Calibration Settings

Calibration setting (KTS & KTA)

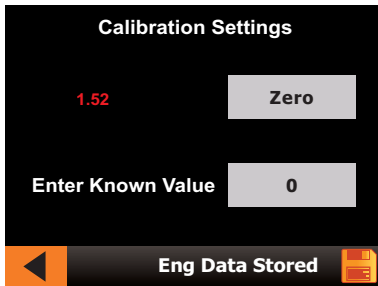

Physically load sensor with known load and enter the known value.

After entering data select save button upon which "calibration data stores".