



**SeethaRam Mechatronics Pvt Ltd**

**Bridging Gaps in Technology**



: [www.seetharam.in](http://www.seetharam.in)



: [ram@seetharam.in](mailto:ram@seetharam.in)

# **Force Pan Cake Compression FPC**

## **USER'S MANUAL**



Read the user's manual carefully before starting to use the unit or software.  
Producer reserves the right to implement changes without prior notice.



# Index

---

<b>Section</b>	<b>Title</b>	<b>Pages</b>
01.	Technical Specification	03
02.	Electrical Connection	04
03.	Product Description	05
04.	Procedure	06
05.	Safety	07
06.	Precautions	09
07.	Warning	10
08.	Do's & Don't's	11
09.	EMC Protection	15

### 1. Technical Specification

Model	FPC
Rated capacity(R.C.)	50, 100, 200, 500kgf, 1, 2, 3, 5, 10tf
Rated output(R.O.)	2mV/V±0.4%
Nonlinearity	0.15% of R.O.
Hysteresis	0.1% of R.O.
Repeatability	0.1% of R.O.
Zero balance	±2% of R.O.
Temperature effect, on rated output	0.1% of R.O./10°C
Temperature effect, on zero balance	0.05% of R.O./10°C
Temperature range, compensated	-10~70°C
Temperature range, safe	-20~80°C
Terminal resistance input	350±50Ω
Terminal resistance output	350±2Ω
Insulation resistance bridge/case	2000MΩ
Excitation recommended	10V (max. excitation 15V)
Safe overload	150% R.C.
Cable length	Ø5mm 4core, 3m

### DIMENSION

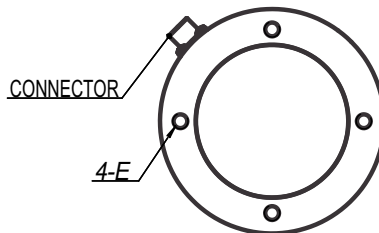
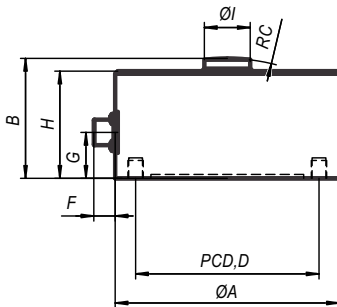

Unit : mm

Capacity	ØA	B	C	D	E	F	G	H	ØI
500kgf, 1tf, 2tf	51	26	25	42	M5x0.8-DP8	8.4	11	22	10
2.5tf, 3tf, 5tf	88	42	75	72	M6x1-DP8	8.4	15	37	18

### 02. Electrical Connection

---

The FPC output signal is mV/V based on strain gauges. An amplifier is required for condition the signal. All DC amplifiers and carrier-frequency amplifiers designed for strain gauge measurement systems can be used.

#### Free cable ends

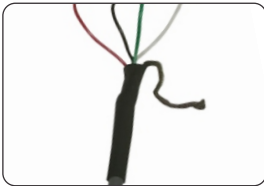

Wire	Function
Black	Signal Positive (Sig +Ve)
Green	Signal Negative (Sig -Ve)
Red	Excitation Positive (Exc +Ve)
White	Excitation Negative (Exc -Ve)
Aluminium Color	Shield 

The output signal is positive for the above connection. If negative output is required, interchange the polarity of output signal.

### 03. Product Description

---

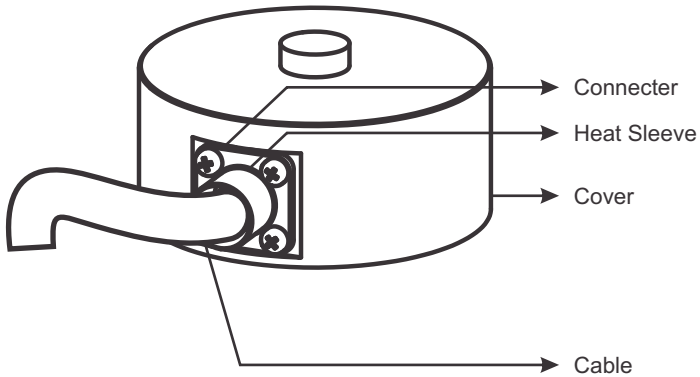

### 04. Procedure

---

Load must be in center in-line whether its compression force.

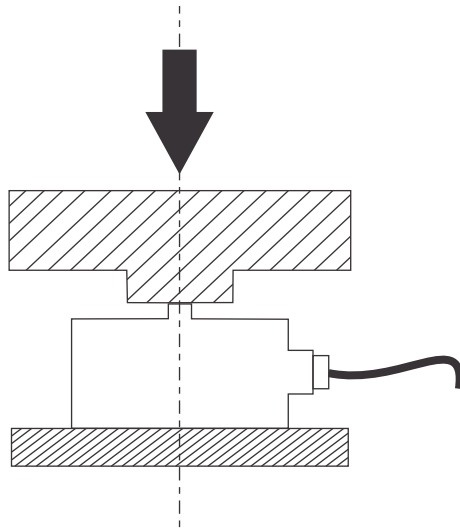

### 05. Safety

---

- When installing the sensor, connect it to an instrument and monitor the output to prevent possible overload.
- If not sure about force to be measured. Use feedback control to prevent sensor from overloaded.

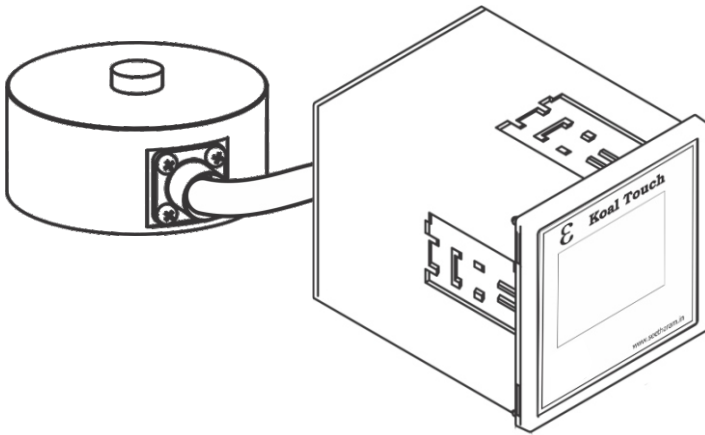

In an environment with a high amount of moisture or humidity, create a drip loop on the cable to prevent any water from flowing into the sensor.



### 05. Safety

---

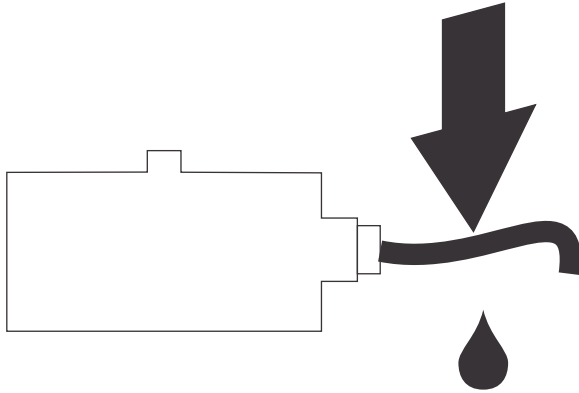

- Make connection according to color code of sensor connection to amplifier.

### 06. Precautions

---

- Do not install the control lines or communication cables together with the main circuit lines or power cables. Keep a distance of 100mm or more between them. Failure to do so may result in malfunction due to noise.
- With cable extensions, ensure that connection is perfect with low contact resistance and continue to connect the cable shield extensively.
- Stray current can destroy the load cell therefore do not pass welding current through the load cells. But never weld closer than 1.2 meter (4 feet) to any load cell without removing the load cell.

#### Note

- Protection class of your force transducer will decrease if the cable connection is not tight and water can penetrate in the cable. Transducers can be irreparably damaged and fail in these circumstances.
- When several force transducers are interconnected, the load/force distribution is not always uniform.

### 07. ⚠ Warning

---

The transducer must not be modified from the design or safety engineering point of view except with our express agreement. Any modification shall exclude all liability on our part for any damage resulting there from.

### 08. ✓ DO'S & ⊗ DON'T

#### Caution

- Do not pull on or carry sensor by cable.
- Be careful not to apply excessive force on or mount anything in contact of the diaphragm area.
- Any tampering or removal of cover, cable and/ or connector will void warranty.

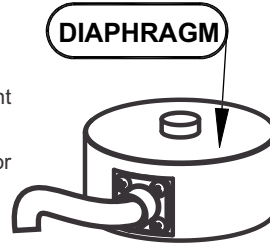

#### Mounting

##### Do's

##### Don't's

1

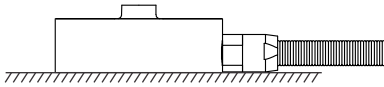

- Flat and even surface required.

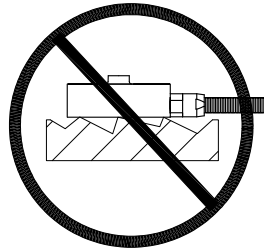

2

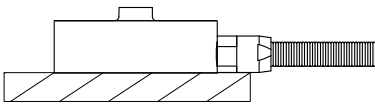

- Maintain clean surface.

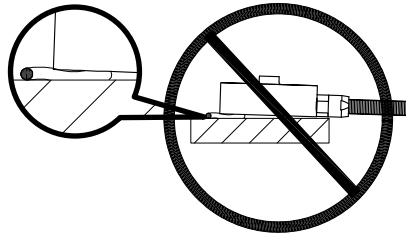

3

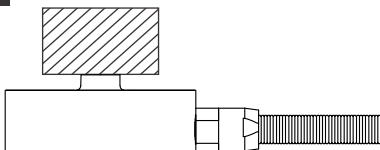

- Fixture must not contact diaphragm area.

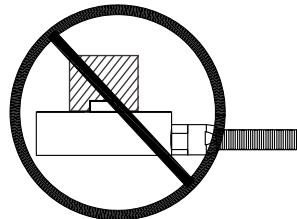

### 08. ✓ DO'S & ⊗ DON'T

#### Caution

- Do not pull on or carry sensor by cable.
- Be careful not to apply excessive force on or mount anything in contact of the diaphragm area.
- Any tampering or removal of cover, cable and/ or connector will void warranty.

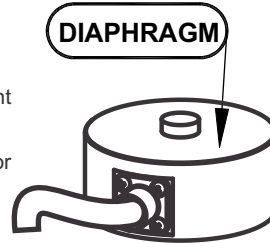

#### Mounting

##### Do's

##### Don't's

1

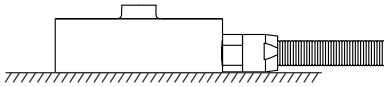

- Flat and even surface required.

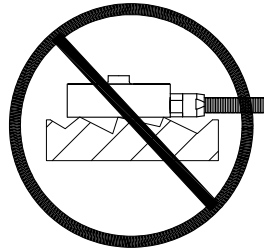

2

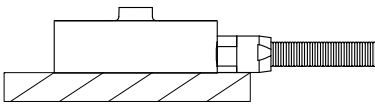

- Maintain clean surface.

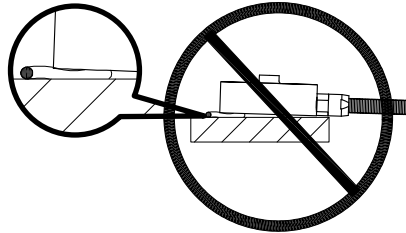

3

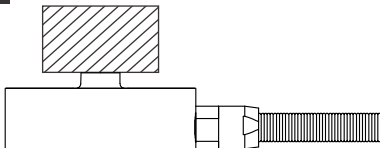

- Fixture must not contact diaphragm area.

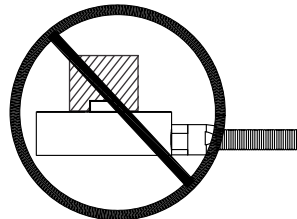

### 08. ✓ DO'S & ✗ DON'T

Do's

Don't's

4

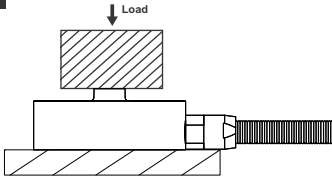

- Fixture load surface must be in line with the sensor.

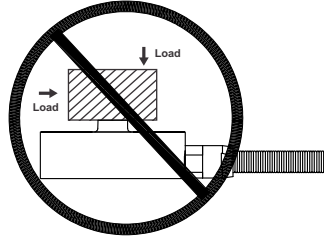

5

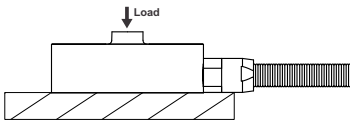

- Load should be applied inline and center of the male thread.

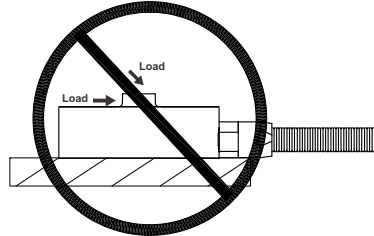

6

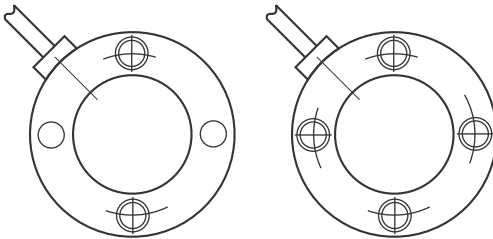

Mount the sensor by tighten screws in a 12 o'clock, 6o'clock, 9 o'clock, and 3 o'clock in a cross like manner (the same technique that is used when bolting your tires).

7

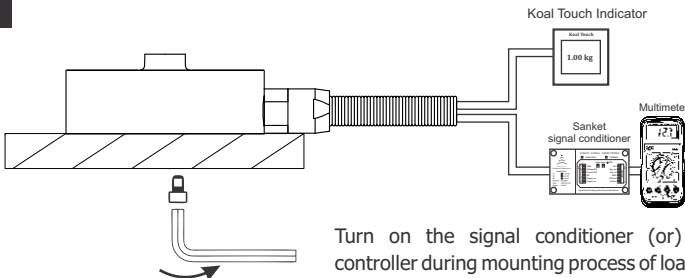

Turn on the signal conditioner (or) indicator controller during mounting process of load cell.

### ✓ DO'S

---

- Visual inspection of product.
- Use stable power supply to prevent high voltage surges.
- Do not remove or tamper the covers of your sensor.
- Monitor the temperature of the environment to ensure that it does not exceed the Sensors operating temperature.
- Use flat, parallel and clean mounting surfaces. A dirty environment or an uneven surface can easily distort your data.
- The warming-up period of the sensor is approximately 5 minutes.
- Make sure that the load you apply on your Load Cell is applied in-line
- For Hydraulic or Pneumatic Pressure applications, slowly monitor the load on the Load Cell to avoid a dynamic overload
- If you think the Load Cell was overloaded, check the zero
- If several bolts are used to mount the sensor, make sure to tighten them down in a 12 o'clock, 6o'clock, 9 o'clock, and 3 o'clock in a cross like manner (the same technique that is used when bolting your tires).
- The sensor package should have included a Calibration Certificate. This is a very important document detailing the calibration data unique to your sensor

### ⊗ DON'T

---

- Exceeding the following
  - a. Limit force
  - b. Lateral limit forces
  - c. Bending and torsional torques
  - d. Breaking forces
  - e. Permissible dynamic loads
  - f. Temperature limits
  - g. Electrical load limits
- Pull or yank on the Load Cell cable.
- Placing heavy fixtures on the Load Cell that may overload it. Again, very critical for low capacity models.
- Pinching and flexing the cable may cause damage, especially if it's left in such a position for extended periods.



### 9. EMC Protection

---

Electrical and magnetic fields can often induce interference voltages in the measuring circuit. Please comply with the measuring circuit. Please comply with the following points:

- Use shielded low-capacitance measurement cables only.
- Do not route the measurement cable parallel to power lines and control circuits. If this is not possible, protect the measurement cable with metal tubing.
- Avoid stray fields from transformers, motors and contact switches
- Please note that compensating currents flowing across the cable shield can cause significant interferences. If the sensor and its evaluation unit have different electrical potentials, an electrical connection with very low resistance must be provided.
- Connect all devices in the measurement chain to the same grounded conductor.
- Always connect the cable shield extensively on the amplifier side, to create the best possible faraday cage.